

# Dennenappel

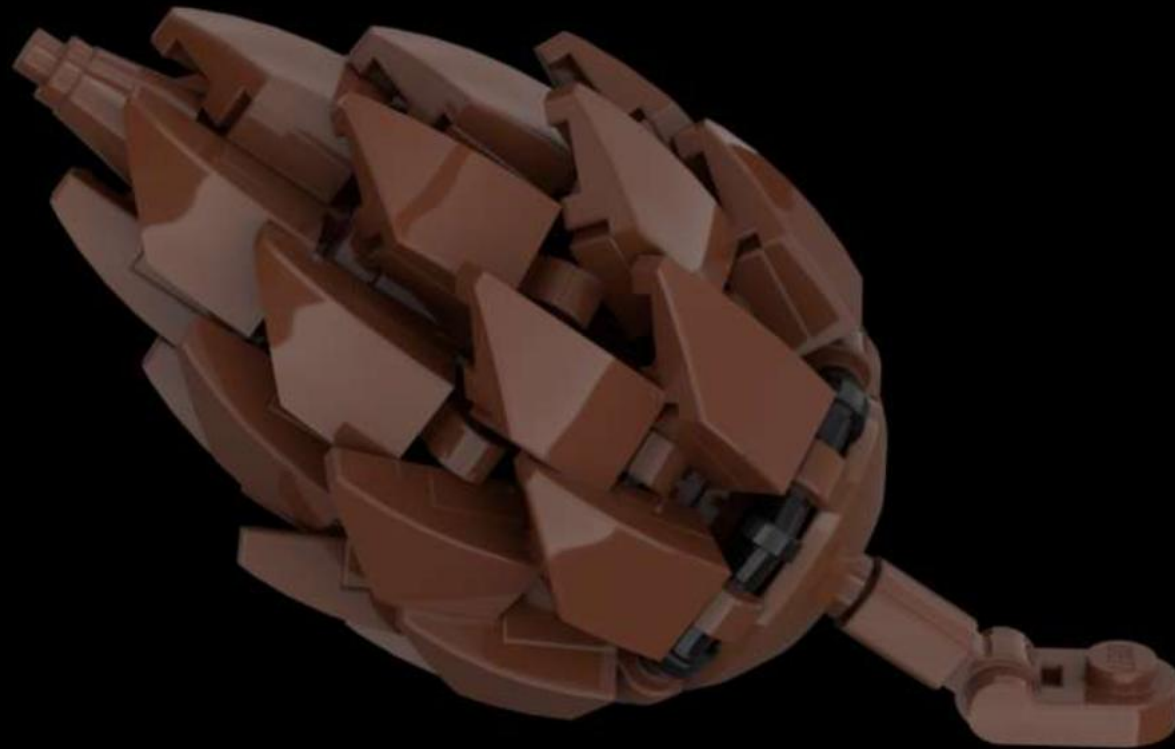

1

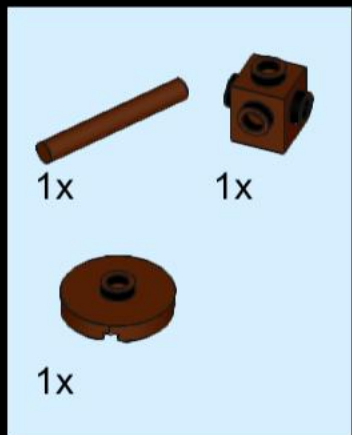

2



3

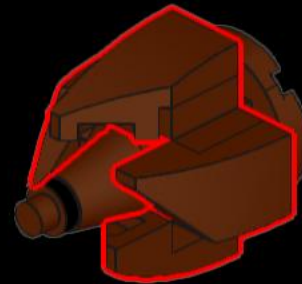
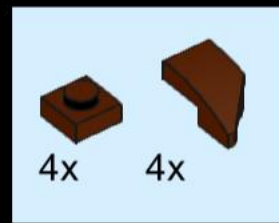

4

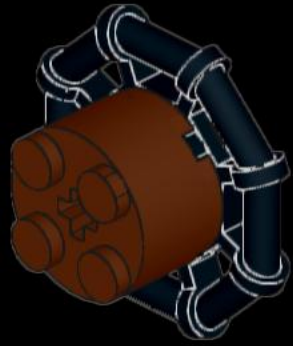
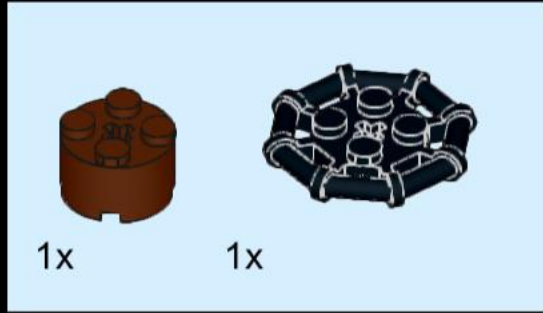

5

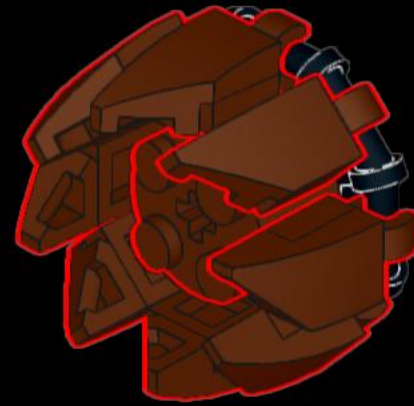
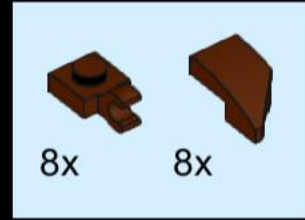

6

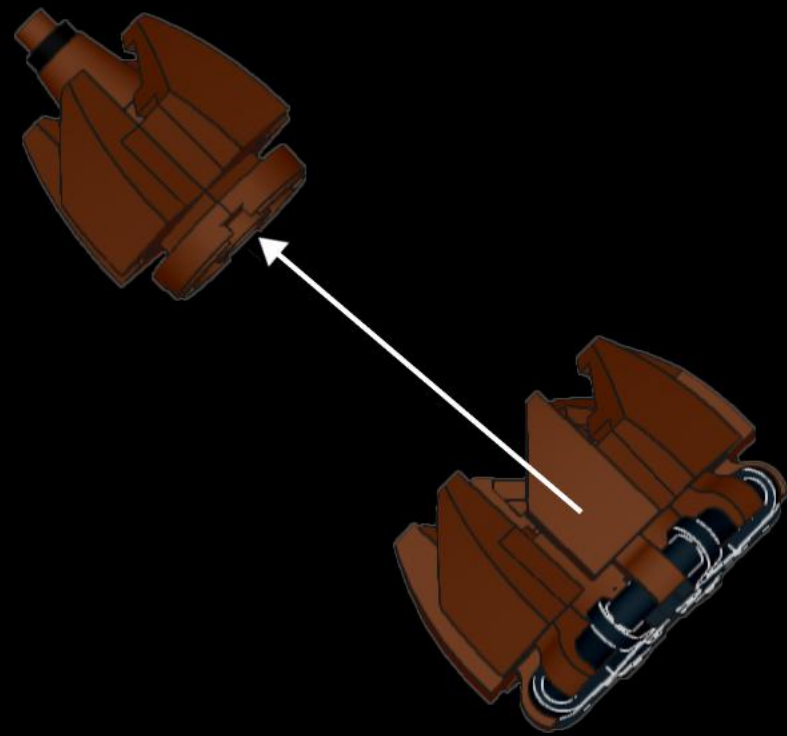

7

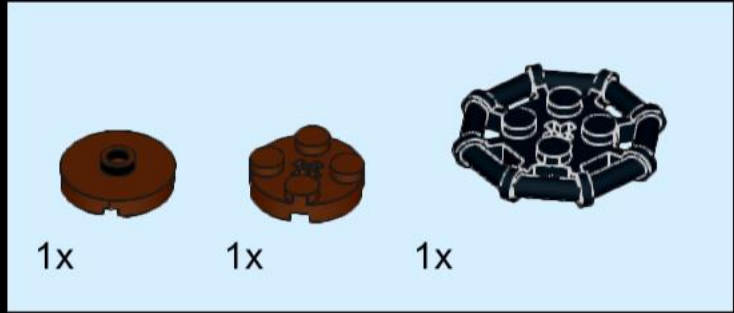

8

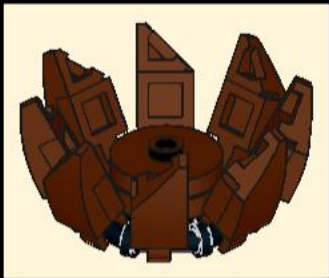
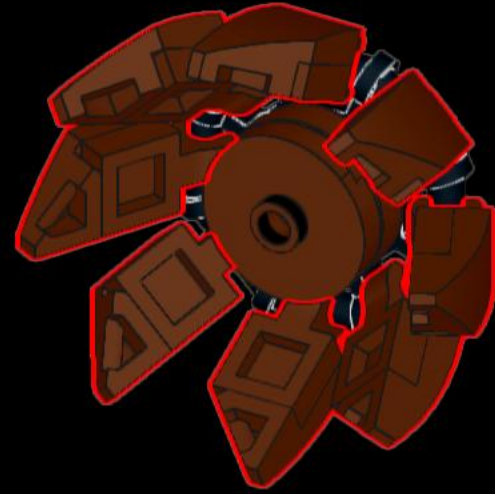
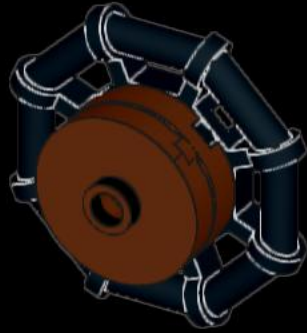
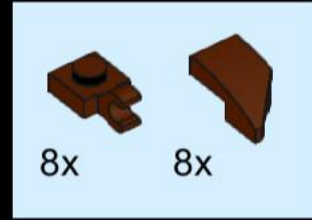

9

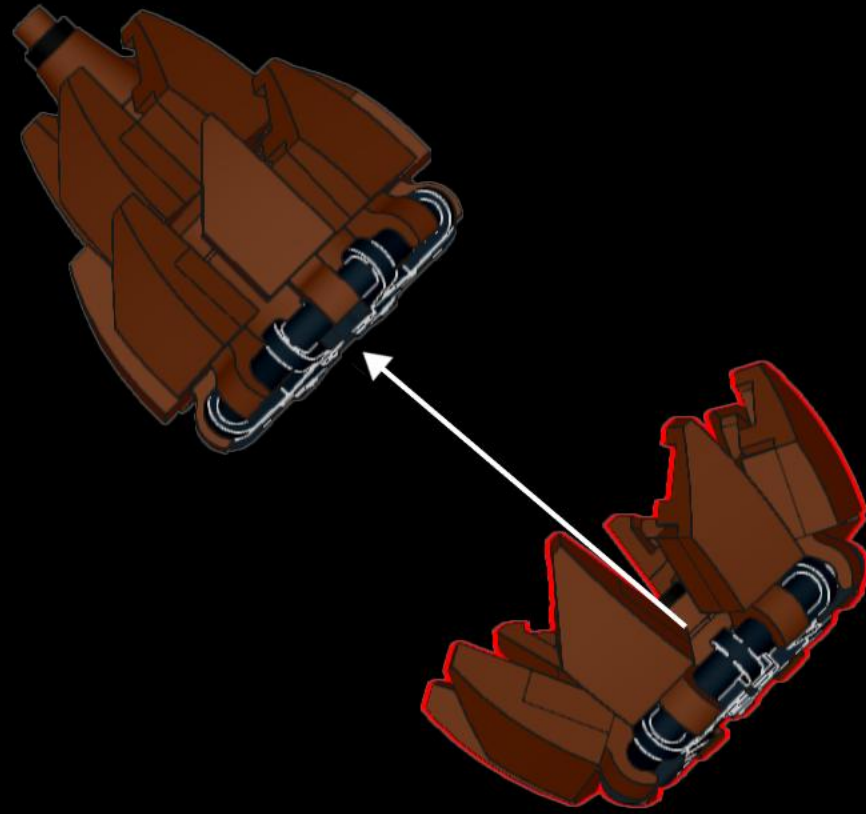

# 10

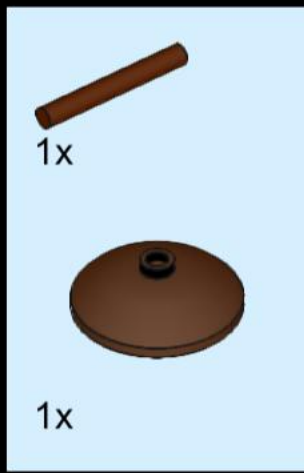

# 11

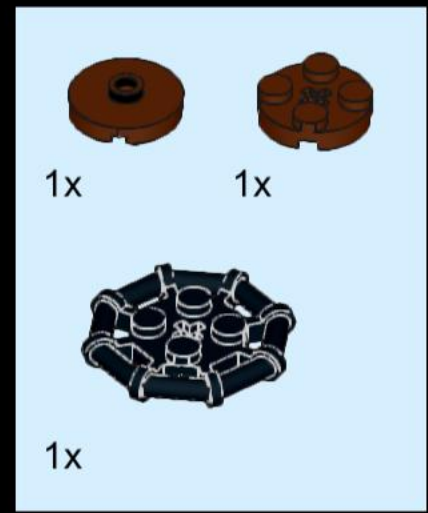

# 12

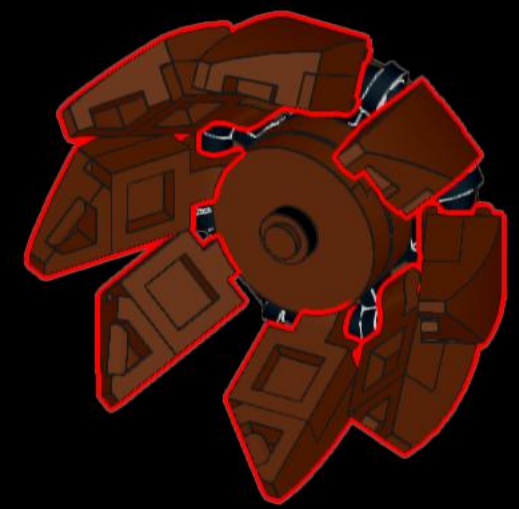
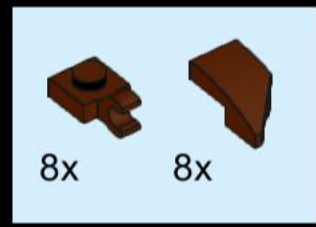

13

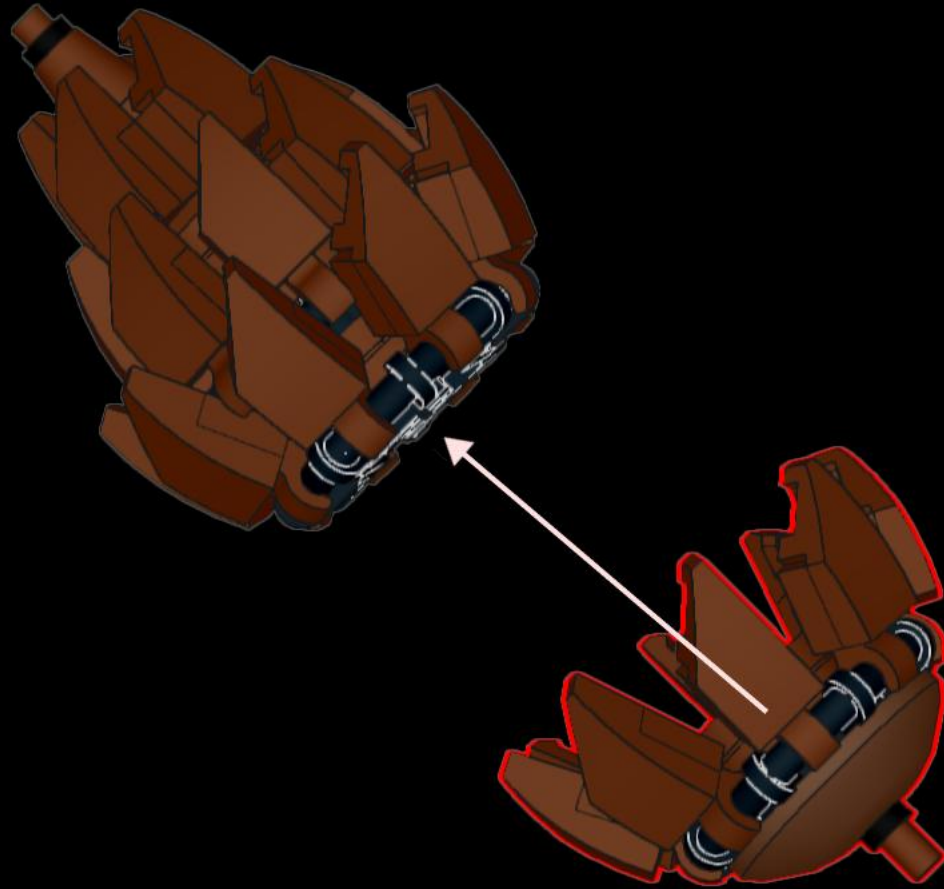



# 14

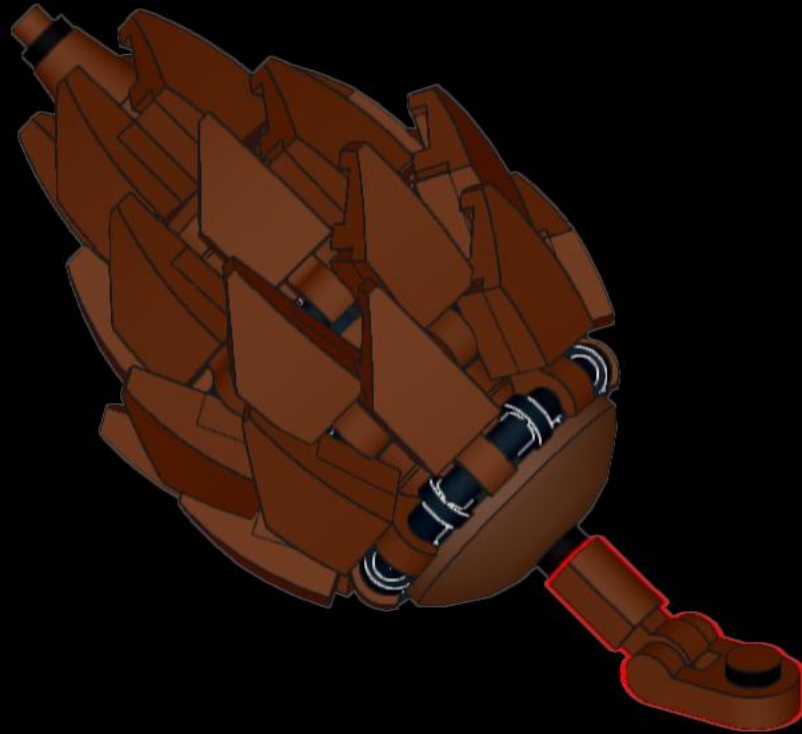
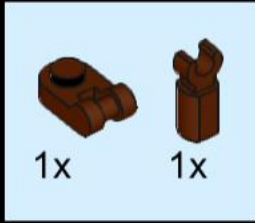



24x  
61252, 88



2x  
87994, 88

3x  
30033, 11



28x  
29120, 88



1x  
3941, 88

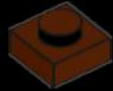

4x  
3024, 88



1x  
4733, 88



1x  
11090, 88



1x  
43898, 8



1x  
4589b, 88

3x  
18674, 88



1x  
26047, 88



2x  
4032, 88